



**TOOLMASTER**

**BT40 x ER40-80 Collet Chuck**

**Ø3-Ø26mm Range**



## TOOLMASTER BT40 x ER40-80 Collet Chuck

### Description

All BT collet chucks meet the specifications of machine tool builders (DIN 2080 taper Shank Grade AT-3 - 85% taper contact)

### Features

- Precision ground
- All ER40 collet chucks are fitted with ball bearing nuts
- Manufactured to MAS403BT40 standard
- M16 Pull Stud thread
- 80mm extension from the gauge line
- Locking spanner not included

### Specifications

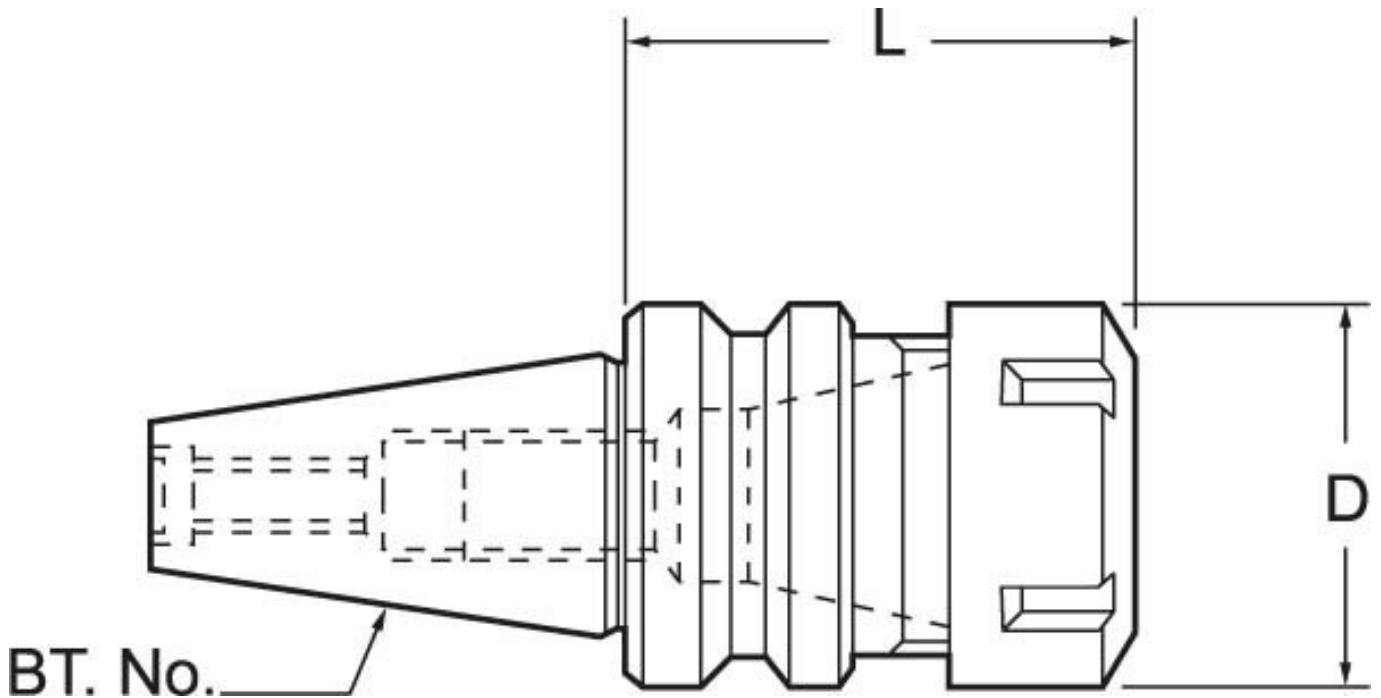

<b>BT. No.</b>	
<b>ORDER CODE</b>	T226
<b>MODEL</b>	BT40 x ER40-80
<b>Speed Rating (rpm)</b>	15,000
<b>Taper (BT)</b>	BT40
<b>Capacity (mm)</b>	3 - 26
<b>L (mm)</b>	80
<b>D (mm)</b>	63
<b>Collet Type (ER)</b>	ER40
<b>Nett Weight (kg)</b>	1.8