

**METALMASTER GB-102.8020**

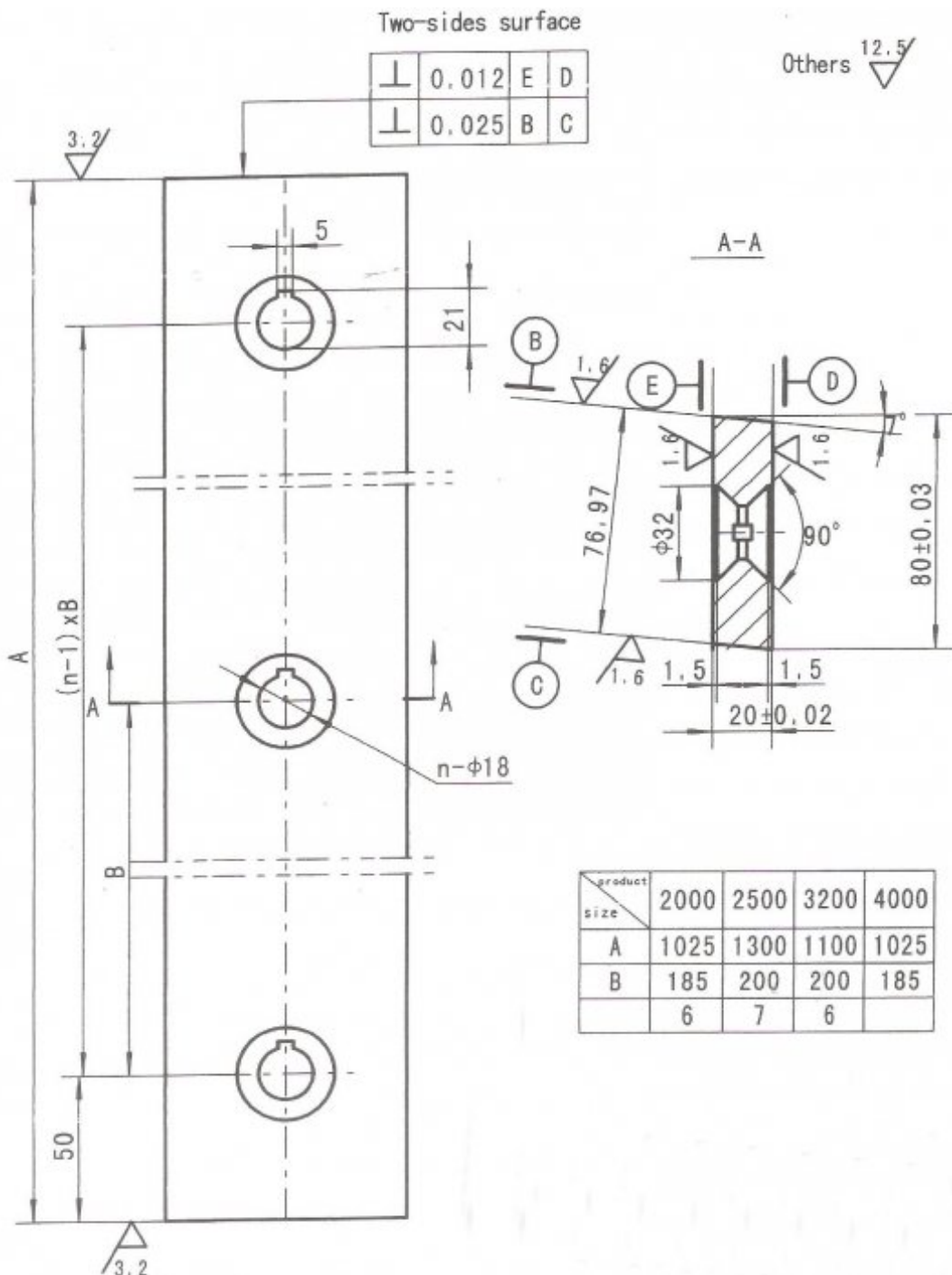

**4000mm Sheet Metal Guillotine Blade Set - 6CrW2Si**

**1025 x 80 x 20mm**



**METALMASTER 4000mm Sheet Metal Guillotine Blade Set - 6CrW2Si GB-102.8020**

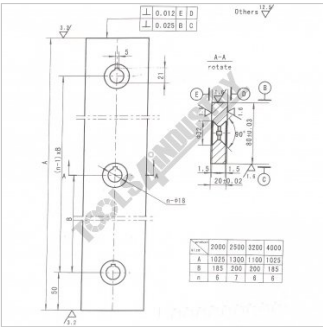

Bottom Blade

**Description**

Blades made from 6CrW2Si material suitable for cutting stainless steel

**Includes**

- Top & Bottom Blade Set

**Specifications**

<b>ORDER CODE</b>	S9988
<b>MODEL</b>	GB-102.8020
<b>Suits Guillotine Cut Length (mm)</b>	4000
<b>Blade Size (mm)</b>	1025 x 80 x 20
<b>Blade Material</b>	6CrW2Si
<b>Top Blade Set</b>	4 Piece
<b>Bottom Blade Set</b>	4 Piece