

MEASUMAX 33-245

Inside Caliper Gauge

30-50mm/1.2-2.0"



MeasumaX



MEASUMAX Inside Caliper Gauge 33-245

Insert

Description

Electronic inside caliper gauges are suited to measuring bores, internal grooves and other hard to reach internal dimensions

Features

- Digital and analogue display on LCD
- Function include Power, Absolute & Incremental
- Metric/Imperial conversion
- Remembers the data of Max. and Min or hold data
- Direct RS232 Output (Uses cable 40-401)
- Auto power off
- Accuracy 0.03mm
- Tolerance set

Includes

- Includes CR2032 battery

Specifications

MEASUMAX Inside Caliper Gauge 33-245

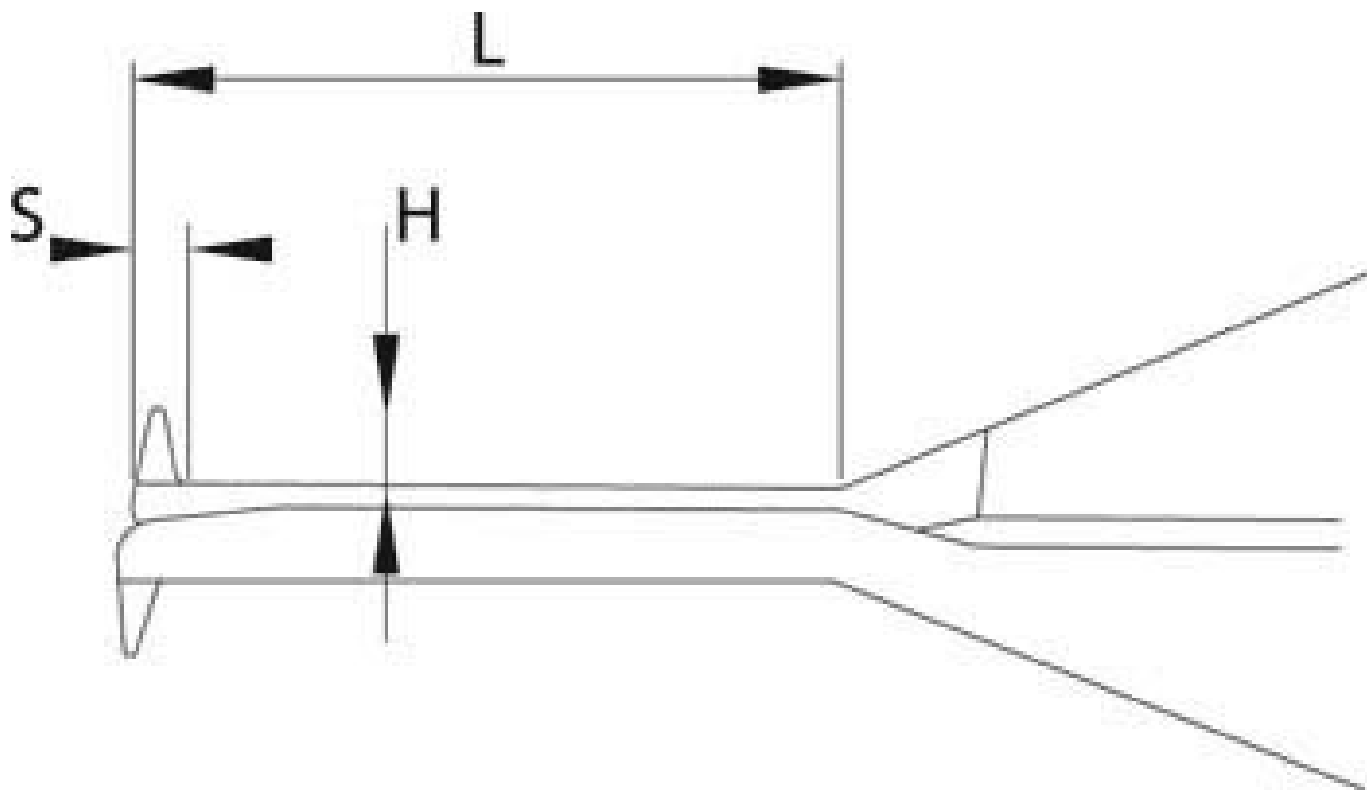

ORDER CODE	Q245
Range	30 - 50mm / 1.2 - 2.0"
Graduations	0.01mm / 0.0005"
L (mm)	80

MEASUMAX Inside Caliper Gauge 33-245

S (mm)	3
H (mm)	8.5