

MEASUMAX 10-124

Digital Outside Micrometer

0-25mm / 0-1"



MeasumaX



MEASUMAX Digital Outside Micrometer 10-124



Shown with Ball Point Adaptor

Description

Quick, accurate and easy to use, at an economical price.

Features

- Large LCD for easy reading
- Metric-imperial conversion and zero setting keys
- Friction thimble for easy one hand use
- Painted frame. Carbide measuring faces
- Resolution: 0.001mm/0.0005"

Includes

- Includes CR2032 battery
- Ball point adaptor for use with round pipe or tubes (wall thickness)

Specifications

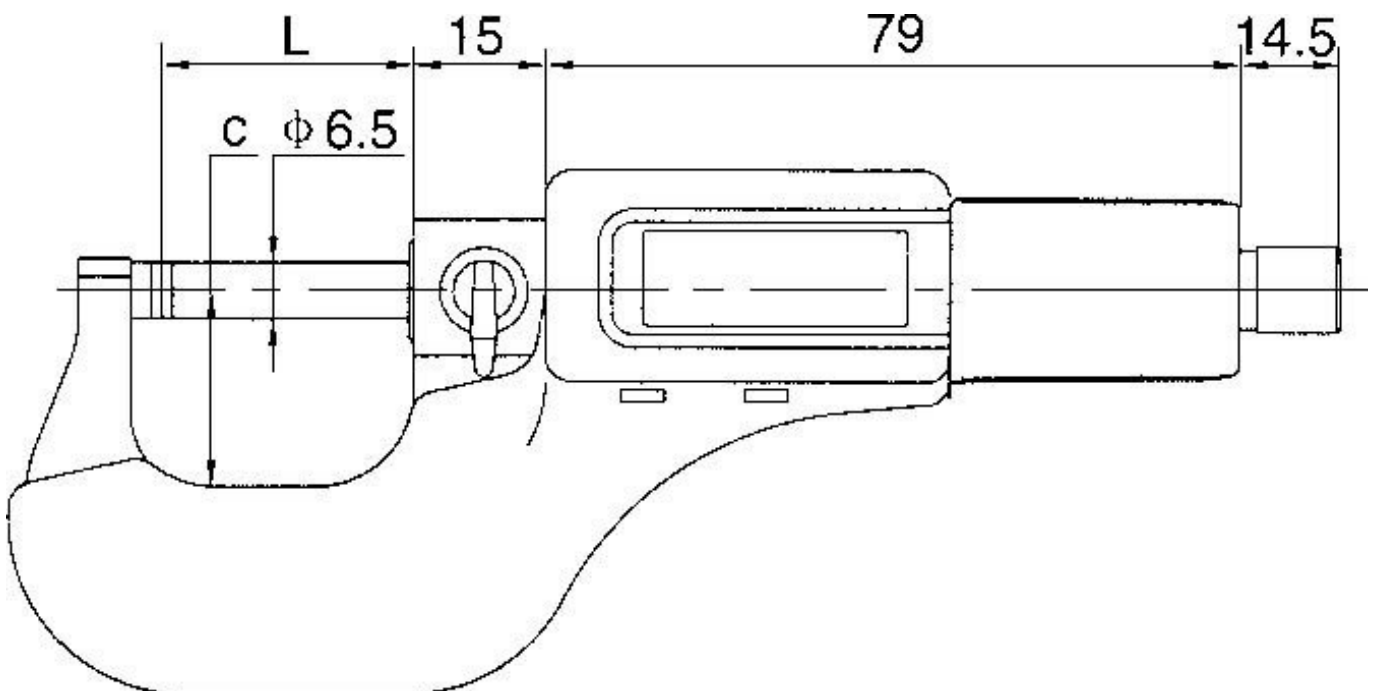

MEASUMAX Digital Outside Micrometer 10-124

ORDER CODE

MEASUMAX Digital Outside Micrometer 10-124

	Q124
Range (mm / inch)	0 - 25mm / 0 - 1"
Accuracy (mm)	±0.002
C (mm)	23
L (mm)	32
Protection Rating	~
Direct RS-232 output (Yes / No)	No