

**SUNRISE**



**14 x 30mm Slotted Punch**

**Hi -Grade Tool Steel Imported From Japan**



**SUNRISE 14 x 30mm Slotted Punch**

Top View

**Description**

Punch and Dies are Manufactured by Sunrise in Taiwan using Hi -Grade Tool Steel imported from Japan.

The manufacturing process involves machining via hi tech CNC machines lathes & mills, vacuum heat treatment with multiple tempering at high temperatures before a final quality inspection/testing process all of which ensures an accurate, precise, durable & stable product.

**Features**

- PLEASE NOTE FOLLOWING RECOMMENDATIONS WHEN SELECTING DIE CLEARANCE:
- Material Thickness - 2 ~ 4mm = Die Clearance 0.2mm
- Material Thickness - 4 ~ 9.5mm = Die Clearance 0.7mm
- Material Thickness - 10 ~ 14.5mm = Die Clearance 1.2mm
- Material Thickness - 15 ~ 19.5mm = Die Clearance 1.7mm
- Material Thickness - 20 ~ 24mm = Die Clearance 2.2mm

**Specifications**

**SUNRISE 14 x 30mm Slotted Punch**

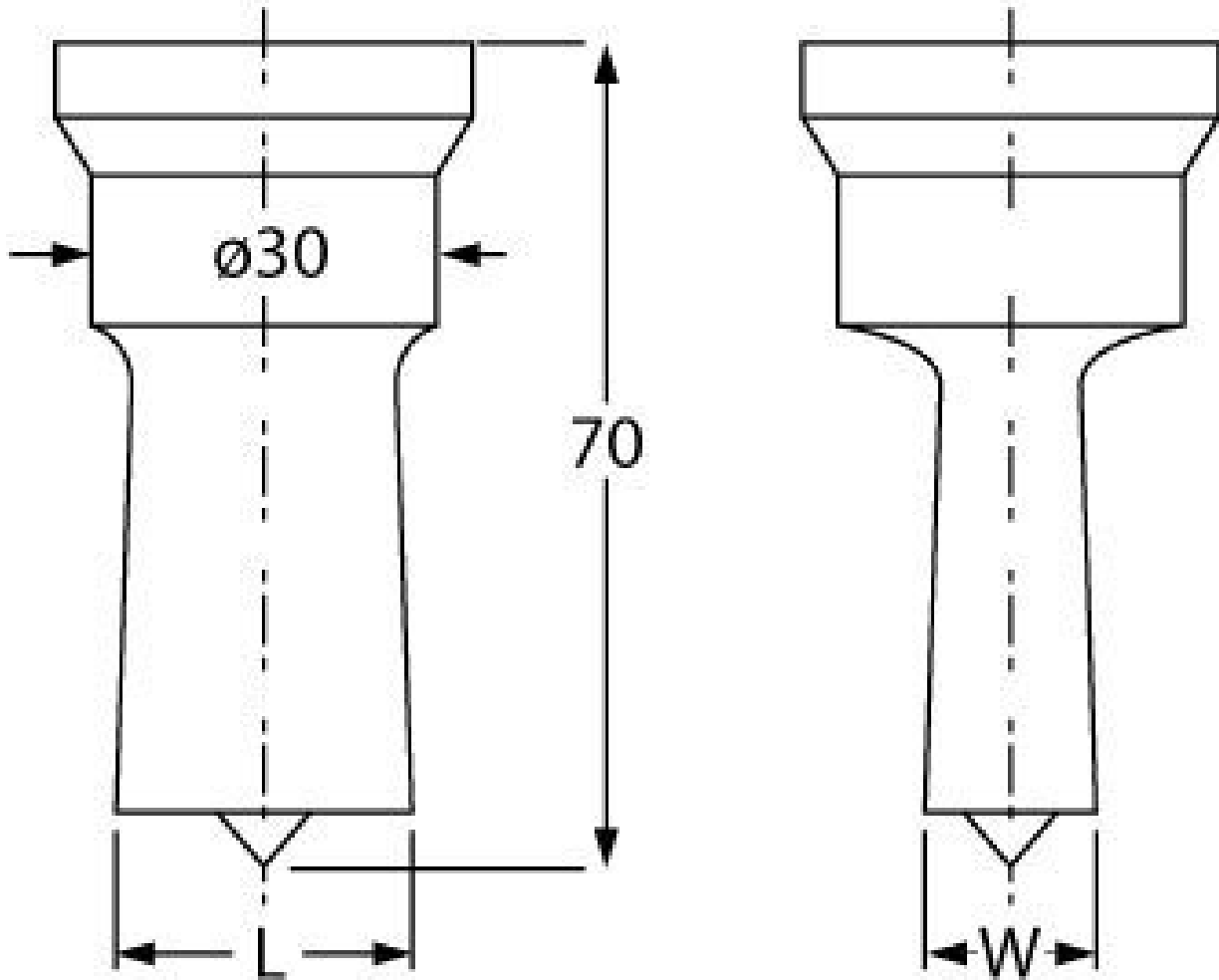

**SUNRISE 14 x 30mm Slotted Punch**

**ORDER CODE**

**SUNRISE 14 x 30mm Slotted Punch**

	P6101
<b>Shape - Type</b>	Slotted Punch - 0P1
<b>Square or Slot Hole Size (W x L) (mm)</b>	14 x 30
<b>Punch Locating Diameter x Length (mm)</b>	Ø30 x 70mm
<b>Die Outside Body Diameter x Height (mm)</b>	~