

SUTTON TOOLS



4mm HSS End Mill - 8% Cobalt



SUTTON TOOLS 4mm HSS End Mill - 8% Cobalt



4 Flute

Description

For precision finish milling applications

Features

- 4 Flute Endmill R30 N
- Suitable for materials up to 1000 N/mm²
- TiCN for longer tool life

Specifications

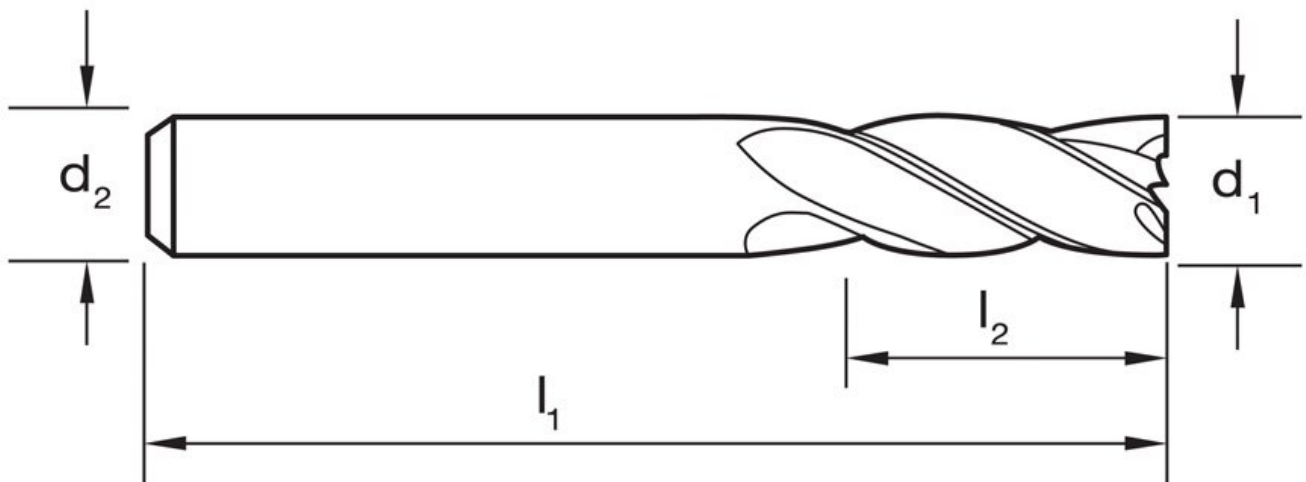

ORDER CODE	M3155
Effective Cutting Diameter (d1)	4mm
Flute	4
Series	~
Type	End Mill

SUTTON TOOLS 4mm HSS End Mill - 8% Cobalt

Shank Size (d2)	6mm
1st Maximum Cutting Depth (l2)	12mm
Overall Length (l1)	60mm
Cobalt (CoHSS)	8% Cobalt
Shank Type	Plain Shank