

TOOLMASTER



NT40-MT4-93 Milling Adaptor



TOOLMASTER NT40-MT4-93 Milling Adaptor

Description

Precision ground and hardened.
 Morse taper adaptors are used to adapt a Morse taper tool or cutter to any spindle taper

Specifications

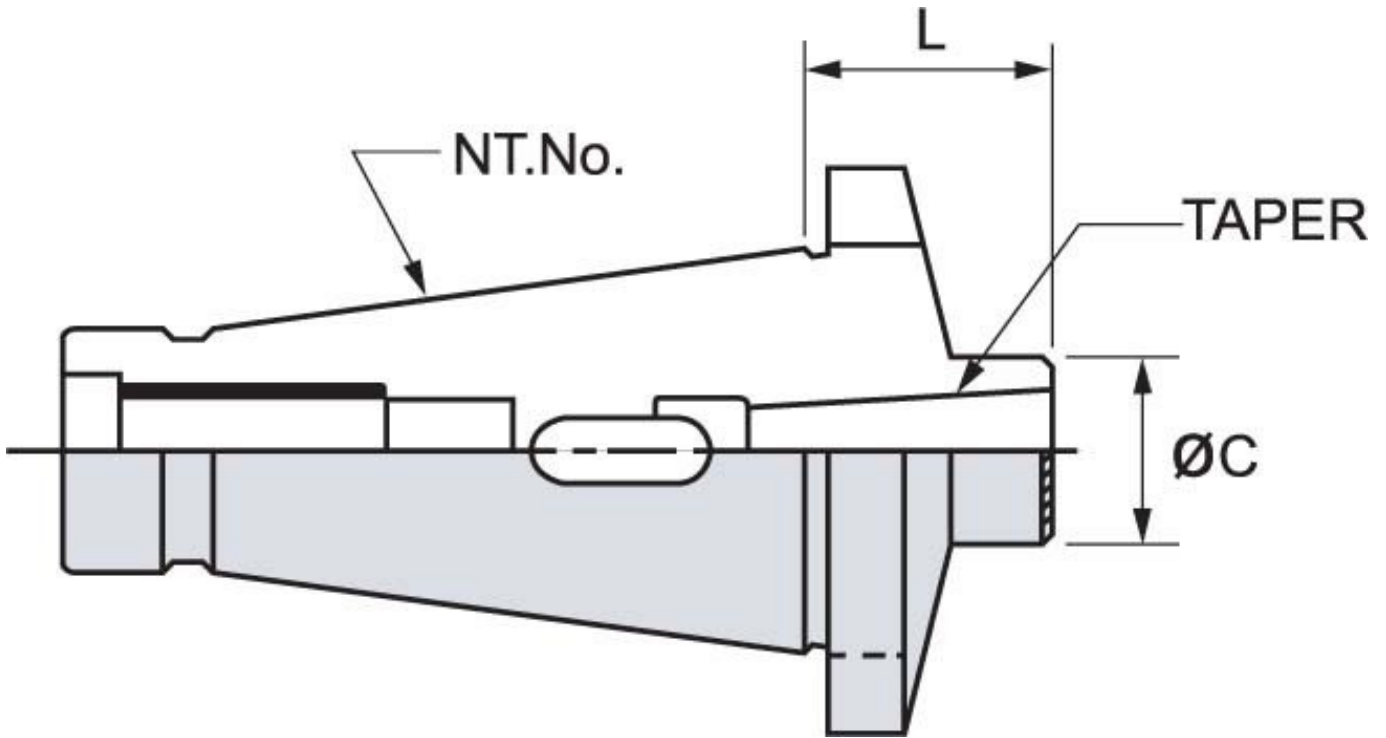

ORDER CODE	M172
MODEL	NT40-MT4-93
Outer Taper	NT40
Inside Taper	MT4
Drawbar Thread (mm / inch)	16mm
L (mm)	93
C (mm)	48
Nett Weight (kg)	1.50