

TOOLMASTER



NT40-MT3-70 Milling Adaptor



TOOLMASTER NT40-MT3-70 Milling Adaptor

Description

Precision ground and hardened.
Morse taper adaptors are used to adapt a Morse taper tool or cutter to any spindle taper

Specifications

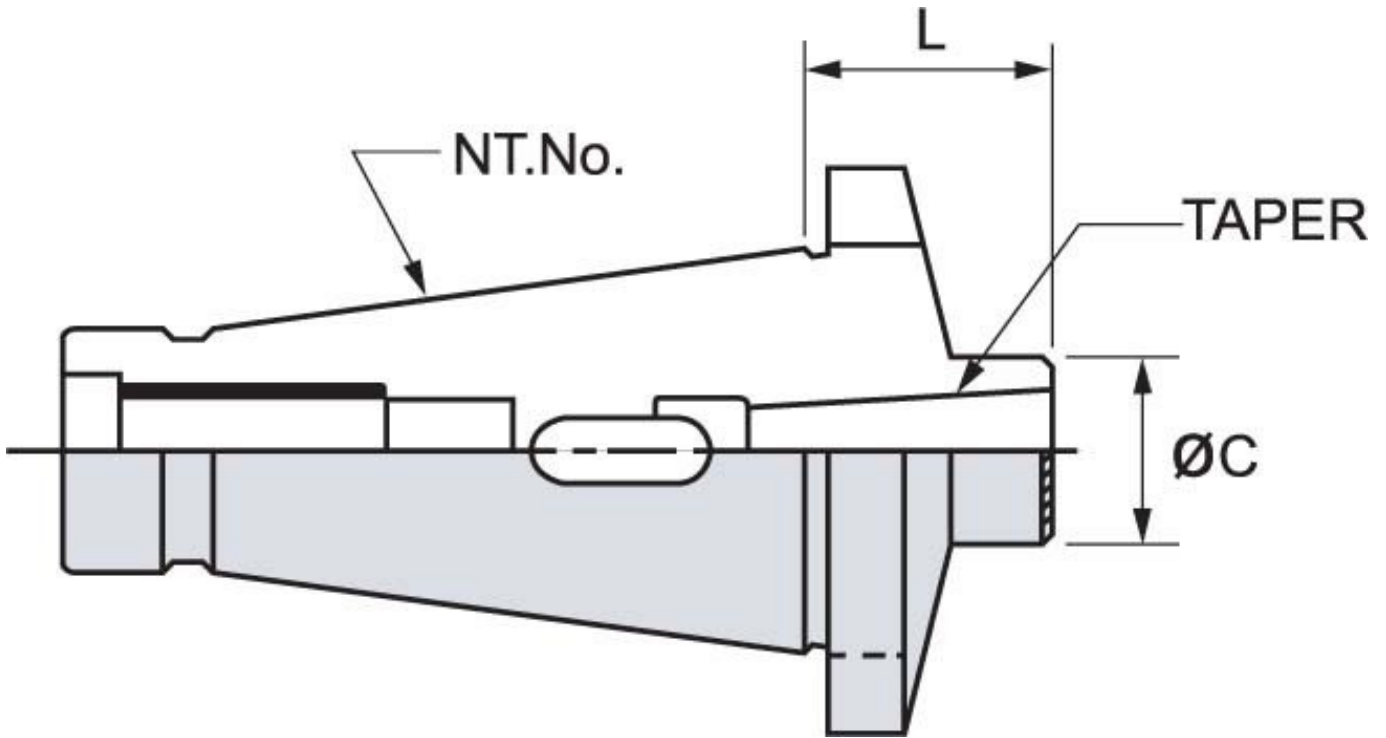

ORDER CODE	M171
MODEL	NT40-MT3-70
Outer Taper	NT40
Inside Taper	MT3
Drawbar Thread (mm / inch)	16mm
L (mm)	70
C (mm)	40
Nett Weight (kg)	1.10