

TOOLMASTER



R8-MT3-50 Milling Adaptor



TOOLMASTER R8-MT3-50 Milling Adaptor

Description

Precision ground and hardened.
Morse taper adaptors are used to adapt a Morse taper tool or cutter to any spindle taper

Specifications

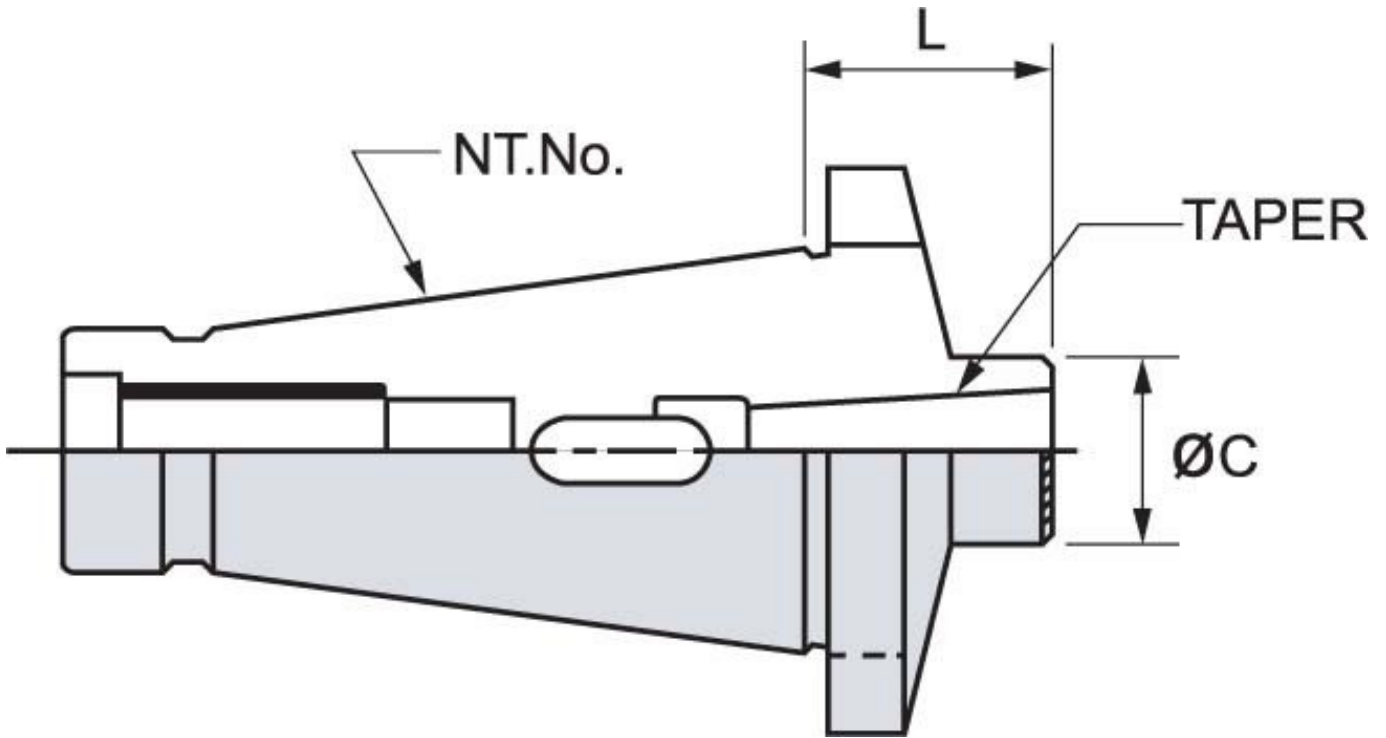

ORDER CODE	M170
MODEL	R8-MT3-50
Outer Taper	R8
Inside Taper	MT3
Drawbar Thread (mm / inch)	7/16"
L (mm)	50
C (mm)	40
Nett Weight (kg)	0.30