

TOOLMASTER



NT40-MT2-40 Milling Adaptor



TOOLMASTER NT40-MT2-40 Milling Adaptor

Description

Precision ground and hardened.
Morse taper adaptors are used to adapt a Morse taper tool or cutter to any spindle taper

Specifications

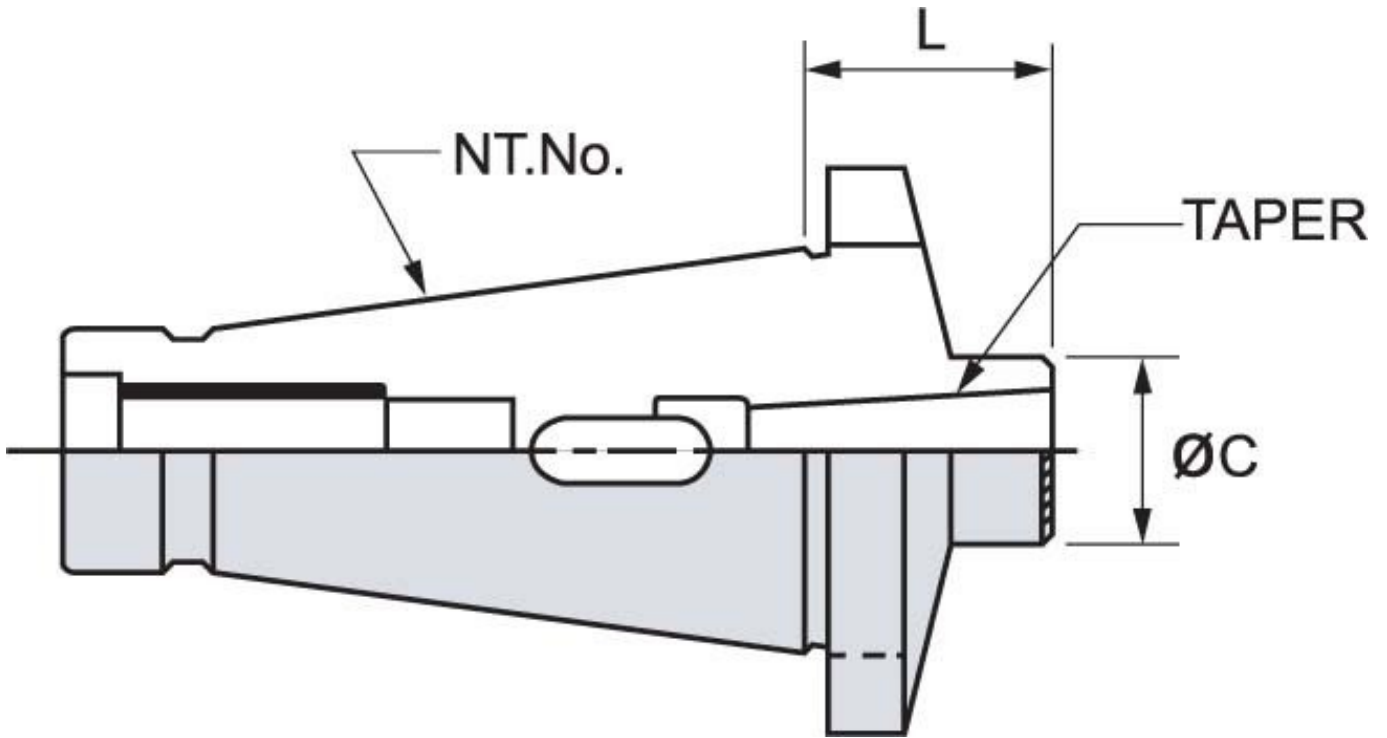

ORDER CODE	M167
MODEL	NT40-MT2-40
Outer Taper	NT40
Inside Taper	MT2
Drawbar Thread (mm / inch)	16mm
L (mm)	40
C (mm)	32
Nett Weight (kg)	1.00