

TOOLMASTER CHR 32-40

Boring Sleeve - Straight

Suits CNC Lathes



TOOLMASTER Boring Sleeve - Straight CHR 32-40

Description

Used in the turrets of CNC lathes to hold boring bars and other cutting tools.
 Universal design allows these sleeves to be fitted to all CNC machines with turrets

Features

- Precision ground
- Slotted so that the turret clamp screws can clamp directly onto the boring bar or cutter

Specifications

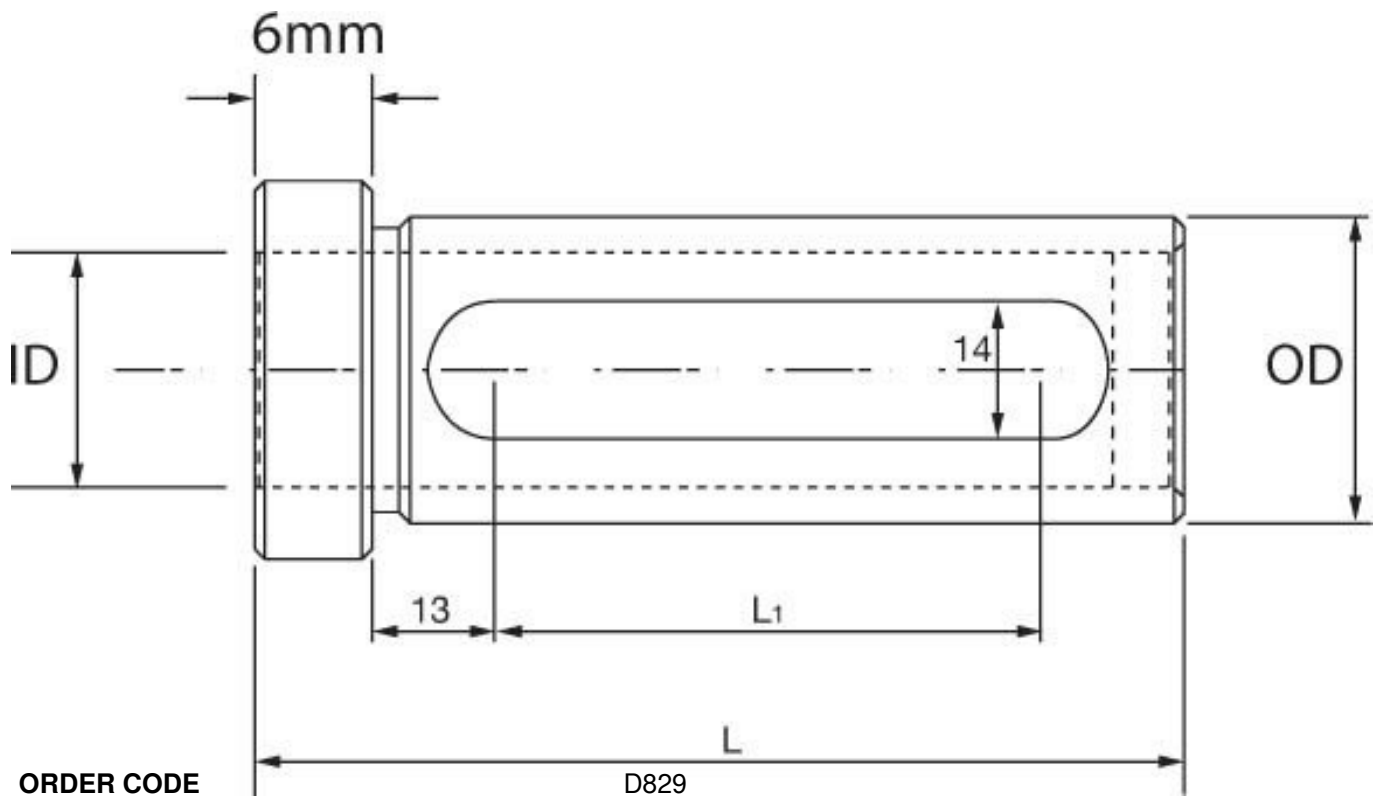

ORDER CODE	D829
MODEL	CHR 32-40
Type	Slot
OD (mm)	40
ID (mm)	32mm
L (mm)	96
L1 (mm)	66