

EASSON



3000mm Easson Digital Readout Scale

VS20 Standard Scale



EASSON 3000mm Easson Digital Readout Scale



DSub9 Male Plug

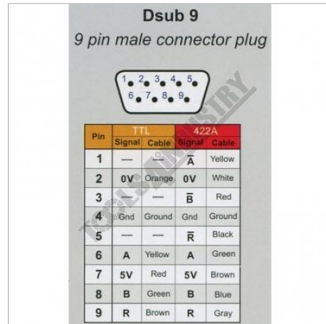

Dsub9 Wiring Diagram



DIY Installation



Parts



Close Up

Description

Easson VS series Glass Grating Linear Transducer: EASSON - Always committed to Quality, Technology & Innovation

Features

- **DOUBLE SEAL DESIGNED SCALES:**
- The plastic seals of the transducer use an innovative material to offer superior oil resistance, high elastic recovery properties and durability, carefully designed lip geometry offer low slide resistance.
- **100% LASER CALIBRATION:**
- All glass grating transducers are individually inspected and calibrated by our in-house laser calibrator to ensure accuracy complies 100% with the specifications.
- **ADVANCED OPTICAL MEASURING SYSTEM:**
- The slide carrier of the VS series scales, use a five bearing design for optical grating linear transducer which has been proven as the most reliable system design in today's market.
- The glass grating slide-ways are lapped, and JIS standard P5 grade bearings are used to achieve smooth and accurate movement and long working life.
- **D.I.Y. INSTALLATION:**
- An easy-to-follow D.I.Y. Installation Manual is supplied with each system, complete with illustrations and mounting brackets.

EASSON 3000mm Easson Digital Readout Scale

Specifications

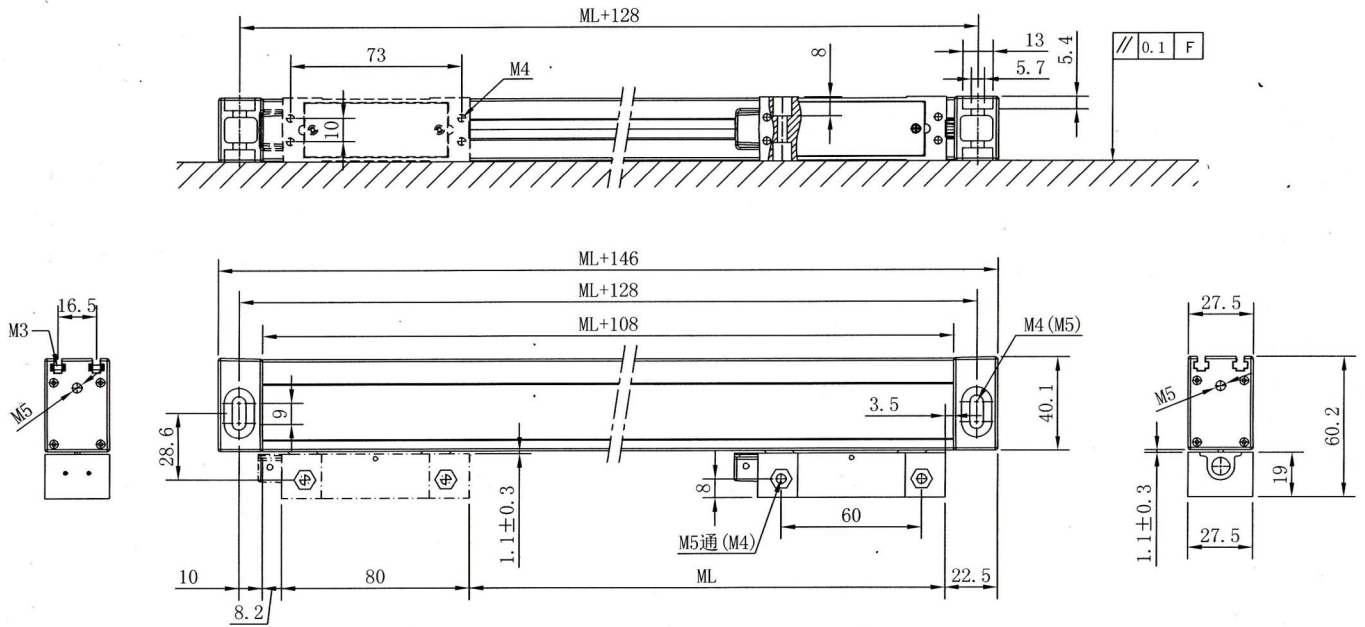

EASSON 3000mm Easson Digital Readout Scale

ORDER CODE

EASSON 3000mm Easson Digital Readout Scale

D750

MODEL	~
Type	VS20 Standard Scale
Travel - Maximum (mm)	3000
Overall Length (L) (mm)	3146
Scale Resolution (µm)	5
Grating Pitch	~
Accuracy (µm)	±10
Output Signal	~
Connector	~
Cable Length (Metre)	9
Working Temperature (°C)	~
Sealing Protection Class	~
Maximum Speed (M/min)	~
Reference Point	~
Width x Height (W x H) (mm)	27.5 x 40.1
Backing Support Plate (Yes / No)	No