

**EASSON**



**1000mm Easson Digital Readout Scale**

**VS10 Standard Scale**



## EASSON 1000mm Easson Digital Readout Scale



DSub9 Male Plug



Dsub9 Wiring Diagram



DIY Installation



Parts



Close Up

### Description

Easson VS series Glass Grating Linear Transducer: EASSON - Always committed to Quality, Technology & Innovation

### Features

- **DOUBLE SEAL DESIGNED SCALES:**
- The plastic seals of the transducer use an innovative material to offer superior oil resistance, high elastic recovery properties and durability, carefully designed lip geometry offer low slide resistance.
- **100% LASER CALIBRATION:**
- All glass grating transducers are individually inspected and calibrated by our in-house laser calibrator to ensure accuracy complies 100% with the specifications.
- **ADVANCED OPTICAL MEASURING SYSTEM:**
- The slide carrier of the VS series scales, use a five bearing design for optical grating linear transducer which has been proven as the most reliable system design in today's market.
- The glass grating slide-ways are lapped, and JIS standard P5 grade bearings are used to achieve smooth and accurate movement and long working life.
- **D.I.Y. INSTALLATION:**
- An easy-to-follow D.I.Y. Installation Manual is supplied with each system, complete with illustrations and mounting brackets.

**EASSON 1000mm Easson Digital Readout Scale**

**Specifications**

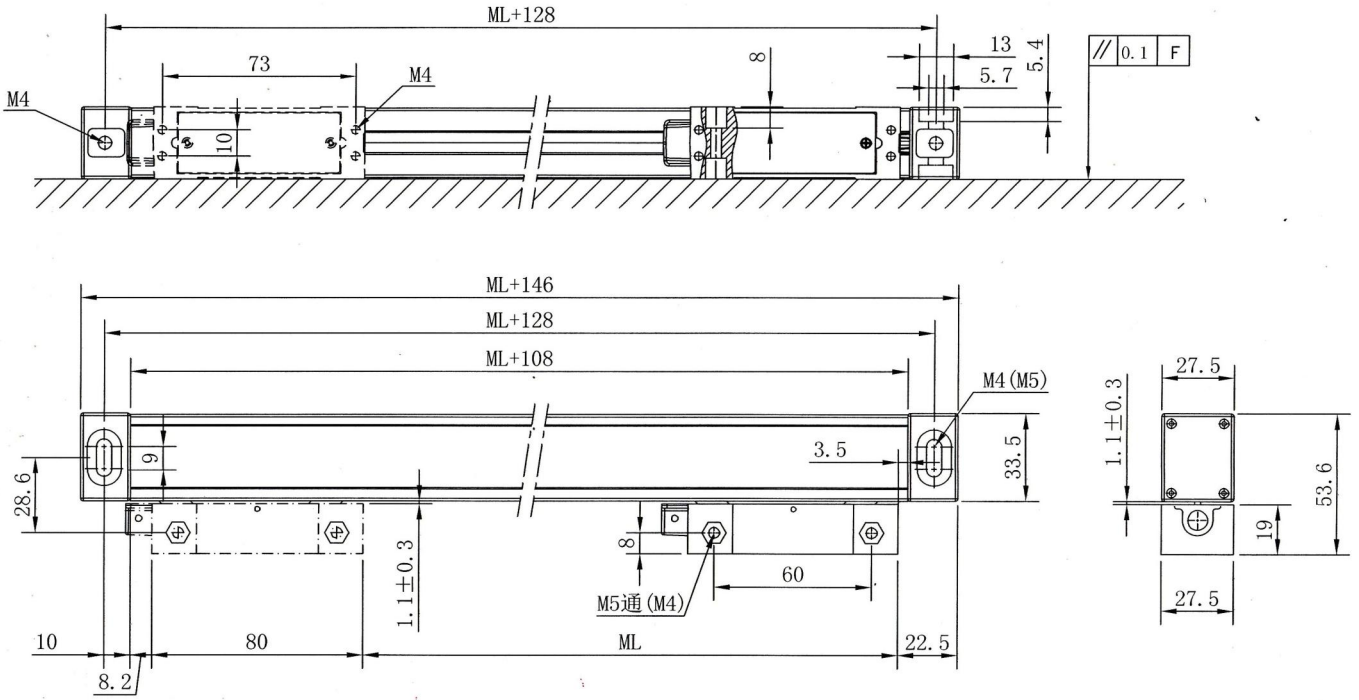

**EASSON 1000mm Easson Digital Readout Scale**

**ORDER CODE**

**EASSON 1000mm Easson Digital Readout Scale**

D736

<b>MODEL</b>	~
<b>Type</b>	VS10 Standard Scale
<b>Travel - Maximum (mm)</b>	1000
<b>Overall Length (L) (mm)</b>	1146
<b>Scale Resolution (µm)</b>	5
<b>Grating Pitch</b>	~
<b>Accuracy (µm)</b>	±10
<b>Output Signal</b>	~
<b>Connector</b>	~
<b>Cable Length (Metre)</b>	3
<b>Working Temperature (°C)</b>	~
<b>Sealing Protection Class</b>	~
<b>Maximum Speed (M/min)</b>	~
<b>Reference Point</b>	~
<b>Width x Height (W x H) (mm)</b>	27.5 x 33.5
<b>Backing Support Plate (Yes / No)</b>	No