



TOOLMASTER

ER32 Collet

Ø18-Ø17mm



TOOLMASTER ER32 Collet

Features

- Manufactured to DIN standard
- Collet size covers a range from expanded to compressed
- Collets from 2mm have 1mm of movement
- Collets are listed by their expanded size
- Eg. When ordering an ER32-3 the range is from 3mm expanded to 2mm compressed

Specifications

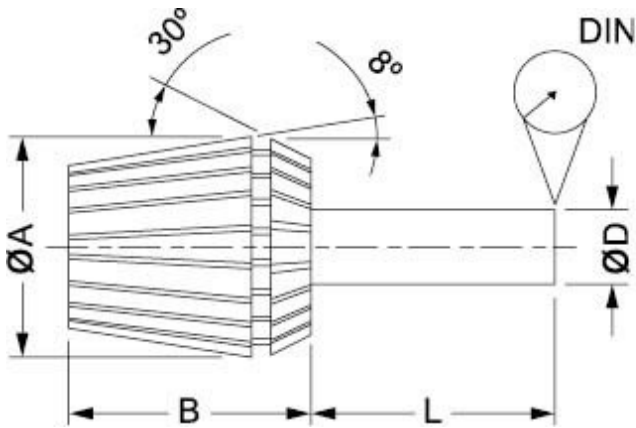

Collet	A	B	L	DIN	RANGE (D)
ER11	11.5	18	6	0.02	0.5-7.0
ER16	17	27	10	0.02	0.5-10.0
ER20	21	31	16	0.02	1.0-13.0
ER25	26	35	25	0.02	1.0-16.0
ER32	33	40	40	0.02	2.0-20.0
ER40	41	46	50	0.03	3.0-26.0

ORDER CODE	C918
Type	ER32
Metric Size (mm)	18 - 17
Imperial Size (inch)	~