

HAFCO



Soft Jaws to suit CNC lathes - Standard

Ø12"



HAFCO Soft Jaws to suit CNC lathes - Standard

Description

Soft Jaws to suit CNC lathes

Features

- Maintains a high level of accuracy
- Serration pitch 1.5 x 60°

Specifications

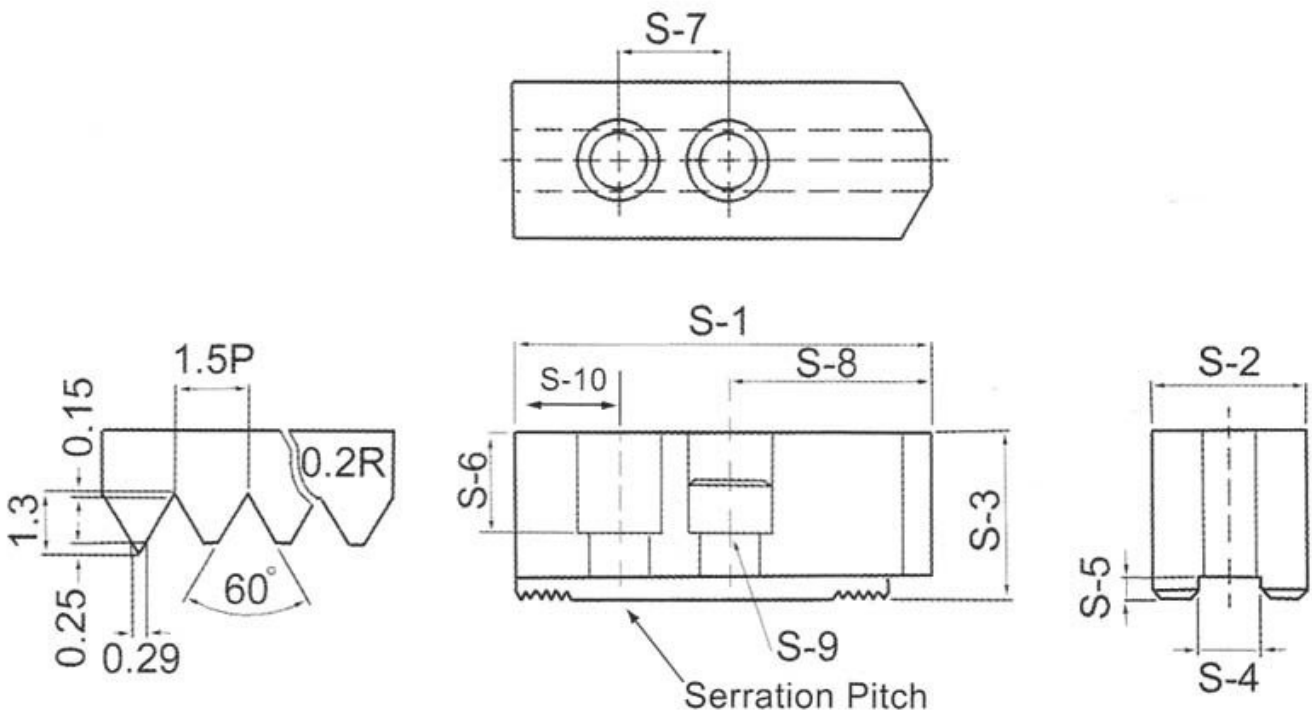

ORDER CODE	C802
Size (inch)	12"
Type	Standard
S-1 (mm)	129
S-2 (mm)	48
S-3 (mm)	48
S-4 (mm)	21
S-5 (mm)	5
S-6 (mm)	28
S-7 (mm)	30
S-8 (mm)	60

HAFCO Soft Jaws to suit CNC lathes - Standard

S-9 (mm)	M16
S-10 (mm)	39
Nett Weight (kg)	6.2