

**HAFCO**



**Soft Jaws to suit CNC lathes - Extra Long**

**Ø8"**



## HAFCO Soft Jaws to suit CNC lathes - Extra Long

### Description

Soft Jaws to suit CNC lathes

### Features

- Maintains a high level of accuracy
- Serration pitch 1.5 x 60°

### Specifications

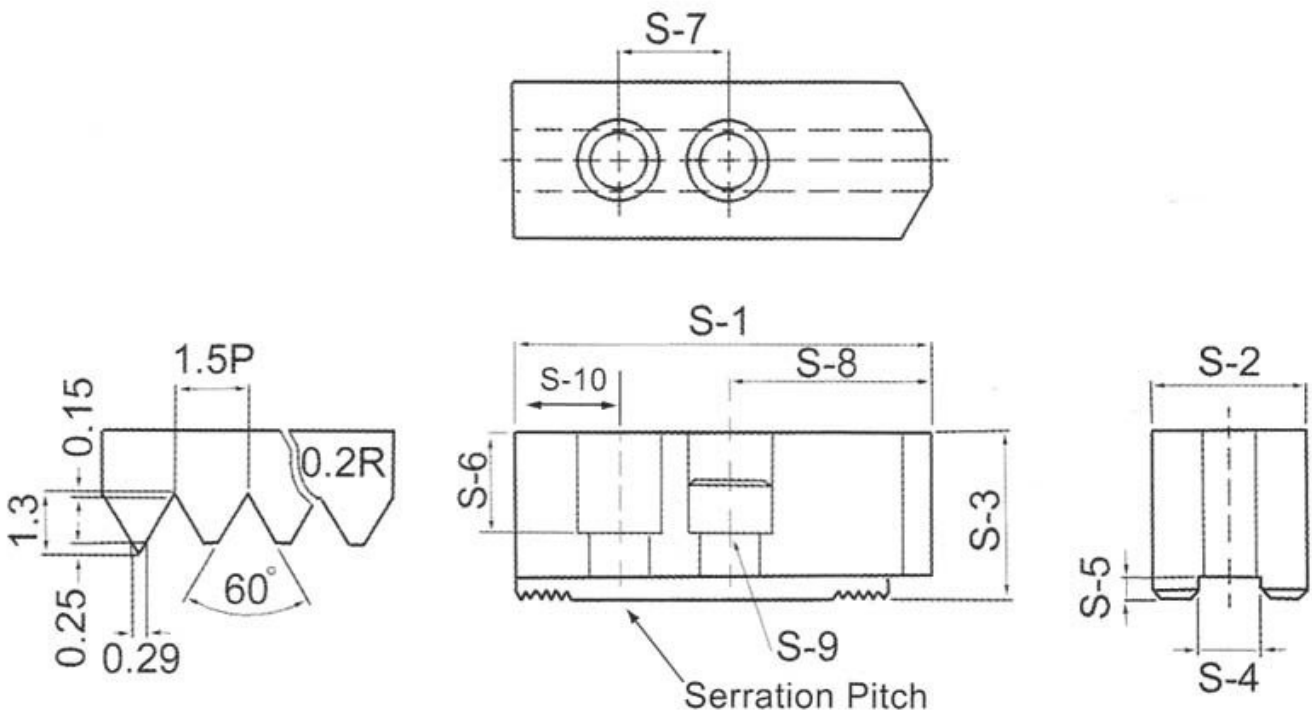

<b>ORDER CODE</b>	C7981
<b>Size (inch)</b>	8"
<b>Type</b>	Extra Long
<b>S-1 (mm)</b>	150
<b>S-2 (mm)</b>	35
<b>S-3 (mm)</b>	48
<b>S-4 (mm)</b>	~
<b>S-5 (mm)</b>	~
<b>S-6 (mm)</b>	~
<b>S-7 (mm)</b>	~
<b>S-8 (mm)</b>	~

**HAFCO Soft Jaws to suit CNC lathes - Extra Long**

<b>S-9 (mm)</b>	~
<b>S-10 (mm)</b>	~
<b>Nett Weight (kg)</b>	~