

**HAFCO**



**Soft Jaws to suit CNC lathes - Standard**

**Ø8"**



## HAFCO Soft Jaws to suit CNC lathes - Standard

### Description

Soft Jaws to suit CNC lathes

### Features

- Maintains a high level of accuracy
- Serration pitch 1.5 x 60°

### Specifications

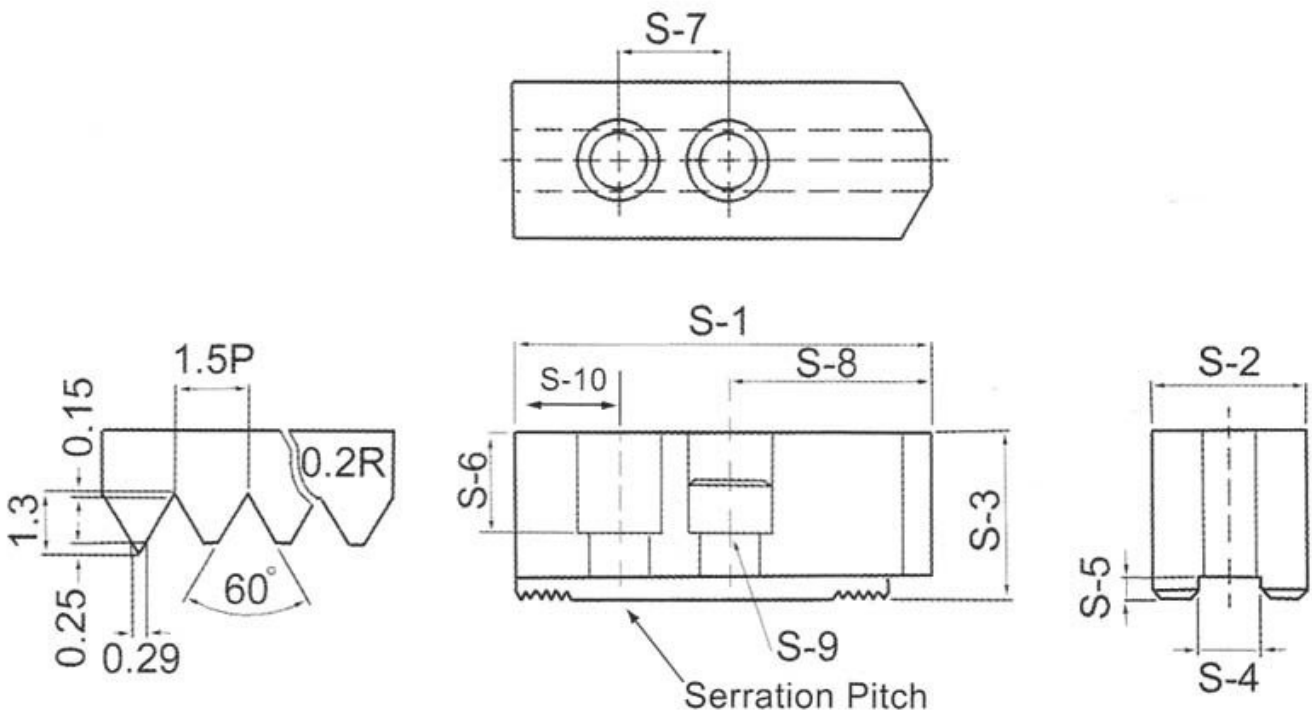

|                    |          |
|--------------------|----------|
| <b>ORDER CODE</b>  | C798     |
| <b>Size (inch)</b> | 8"       |
| <b>Type</b>        | Standard |
| <b>S-1 (mm)</b>    | 95       |
| <b>S-2 (mm)</b>    | 35       |
| <b>S-3 (mm)</b>    | 37       |
| <b>S-4 (mm)</b>    | 14       |
| <b>S-5 (mm)</b>    | 5        |
| <b>S-6 (mm)</b>    | 22       |
| <b>S-7 (mm)</b>    | 25       |
| <b>S-8 (mm)</b>    | 46       |

**HAFCO Soft Jaws to suit CNC lathes - Standard**

|                         |     |
|-------------------------|-----|
| <b>S-9 (mm)</b>         | M12 |
| <b>S-10 (mm)</b>        | 24  |
| <b>Nett Weight (kg)</b> | 2.3 |